

Article number: 0906161063

Description: KLEE Feather keys B 16x10x63 DIN 6885

Measures

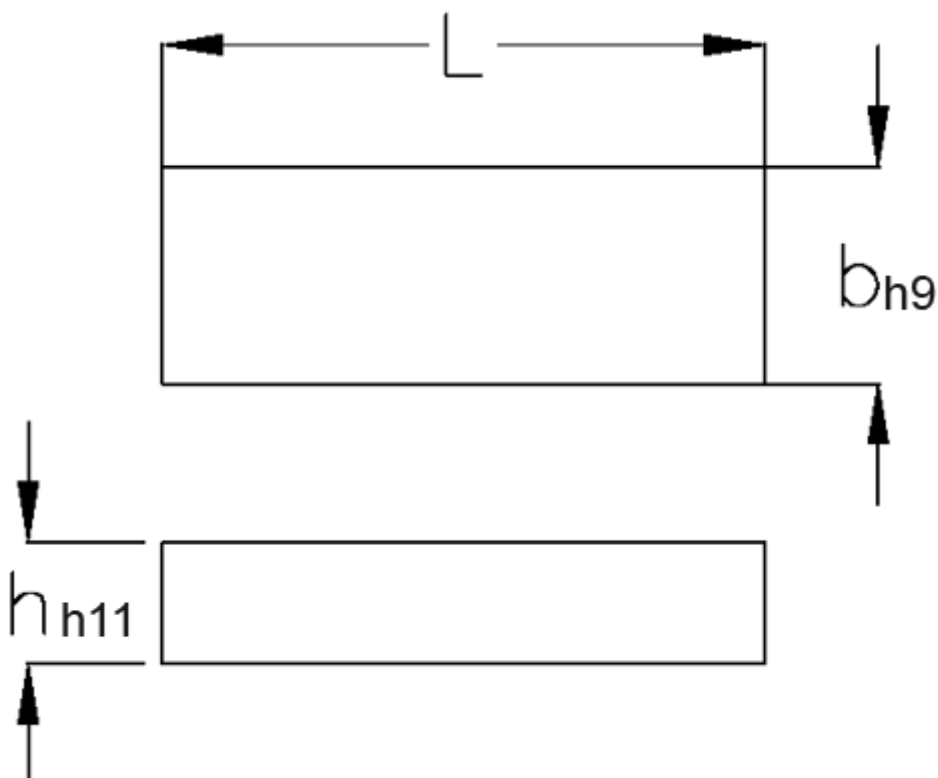

b	= 16
h	= 10
L	= 63
Tolerance b	= 0.043
Tolerance h	= 0.090
Tolerance L	= -0,3